

REVISION RECORD				
REV.	DESCRIPTION	ECN No.	APPROVED	DATE

技术参数/Technical specification

插芯 Inserts	
• 接插件针数 Number of contacts	24+PE
• 额定电流 Rated current	16A
• 额定电压 Rated voltage	500V
• 额定脉冲电压 Rated impulse voltage	6KV
• 污染程度 Pollution degree	3
• 绝缘电阻 Insulation resistance	$\geq 10^{10} \Omega$
• 材料 Material	聚碳酸酯 Polycarbonate
• 颜色 Colour	RAL7032 灰白 Light grey
• 依据UL/CSA额定电压 Rated voltage acc. to UL/CSA	600V
• 工作温度范围 Limiting temperatures	-40°C~+125°C
• 依据UL94阻燃等级 Flammability acc. to UL94	V0
• 可拔插次数 Mechanical working life (mating cycles)	≥ 500

插针 Contacts	
• 材料 Material	铜合金 Copper alloy
• 表面处理 Surface	镀银 Silver plated
• 接触电阻 Contact resistance	$\leq 5m\Omega$
• 接线方式 Terminal	直插式连接 Push-in
• 导线规格 Wire gauge mm ² /AWG	0.5~2.5mm ² /AWG 20~14
• 拧紧力矩 Tightening torque	M3/0.5 N.m M4/1.2 N.m
• 剥线长度 Stripping length	8~10mm

备注：仅使用带冷压头的柔性导线
 Note: Only use flexible wires with cold pressing heads

未注公差按DIN ISO 2768-c
 Undeclared tolerance according to DIN ISO 2768-c

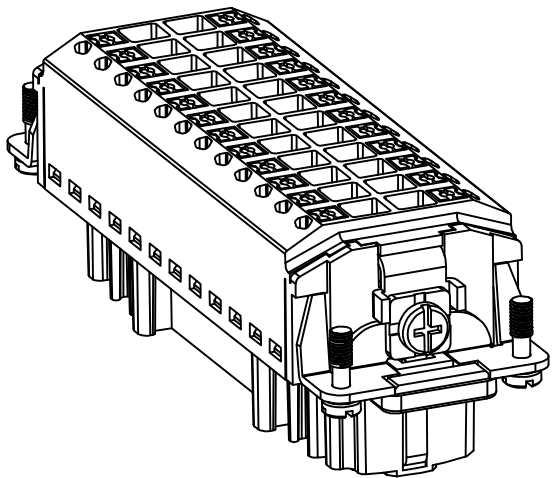
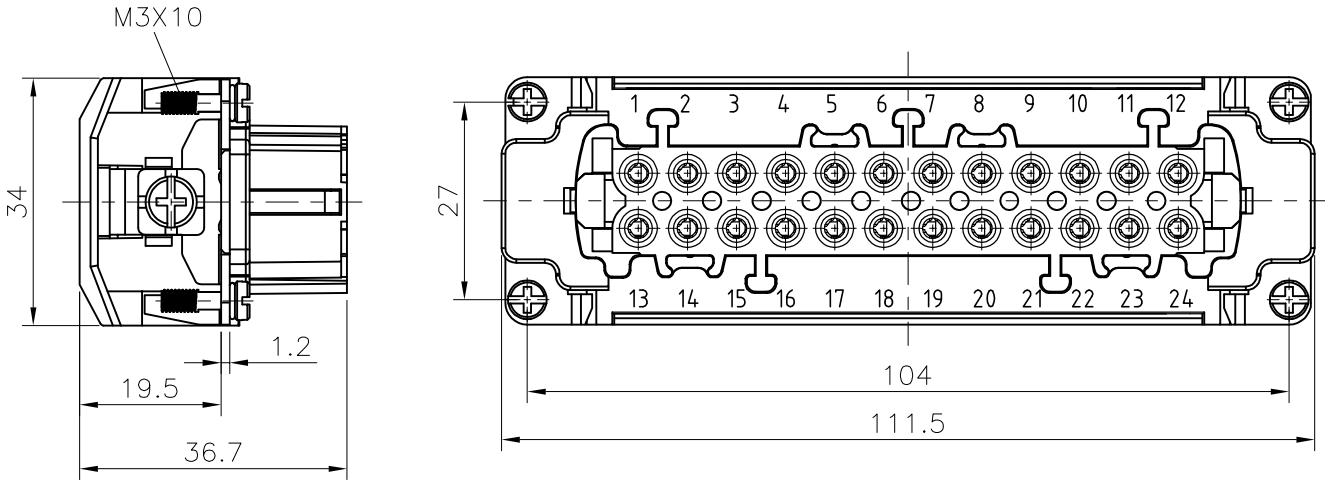

DES.	CHEN HK	DATE	2023. 07. 05	单位 / UNITS	mm	尺寸 / SIZE	A4	比例 / SCALE	1:1	第三视角 / THIRD ANGLE PROJECTION	版本 / REV	A
CHK.	CEN LF	DATE	2023. 07. 05	 慈溪市科发电子有限公司 CIXI KEFA ELECTRONICS CO., LTD				名称 / TITLE	 KE-024-FP			
APP.	HUANG DK	DATE	2023. 07. 05									